

Atividade 3

2) Dado à perspectiva isométrica da peça, faça a mão livre à respectiva representação ao lado em forma de vistas: frontal; superior e lateral esquerda. Respeite as proporções de cada peça e represente as superfícies ocultas com linhas tracejadas.

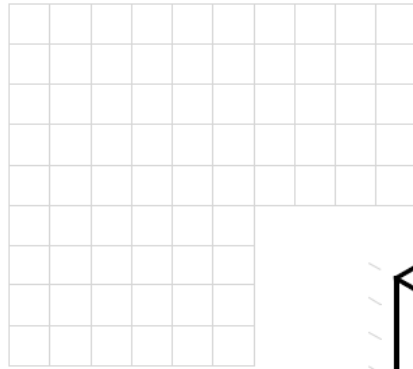

11

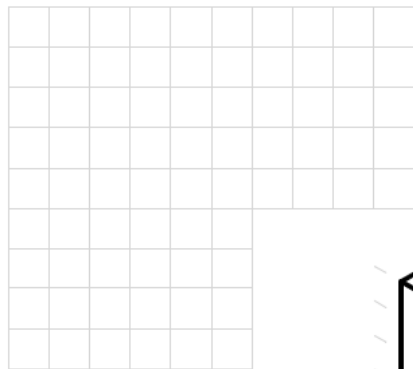
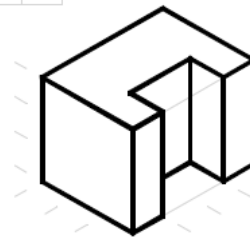

12

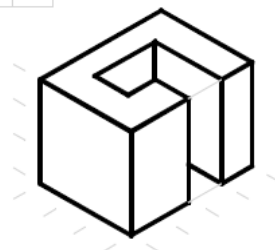

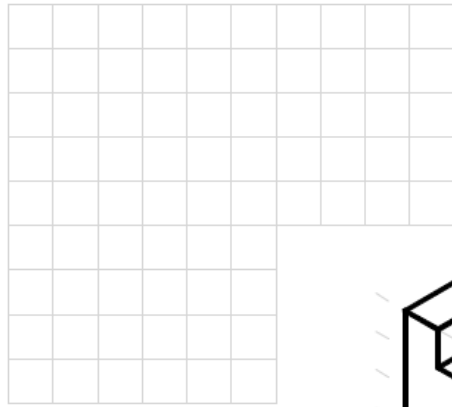

13

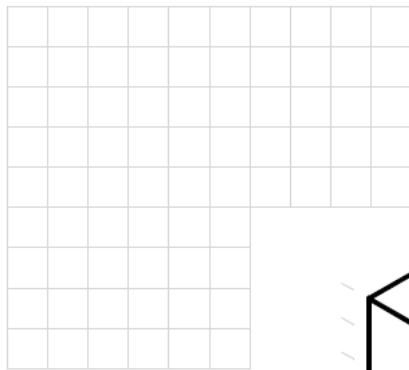
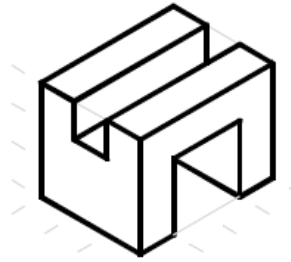

14

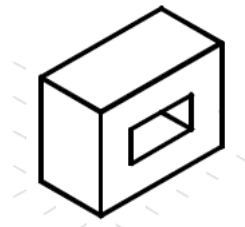

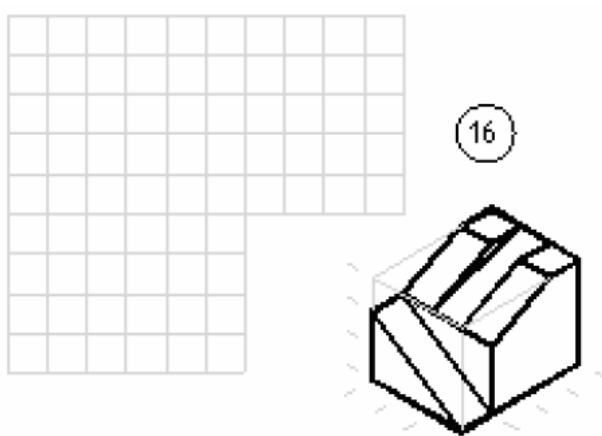
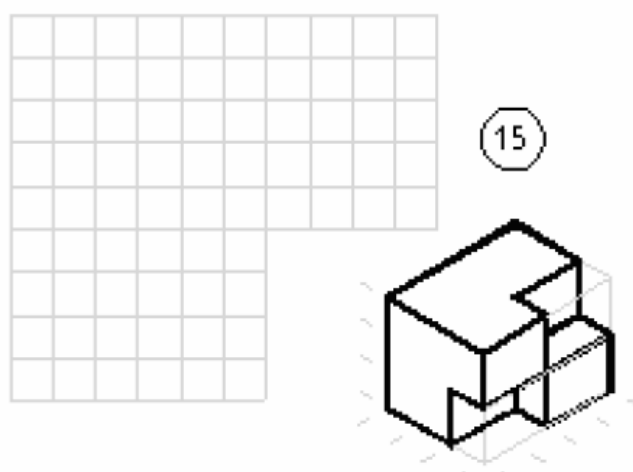

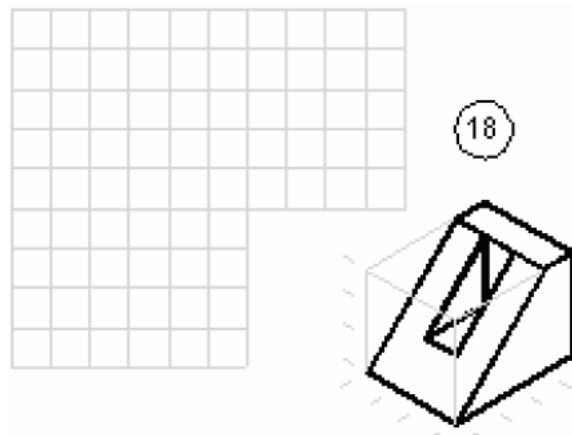
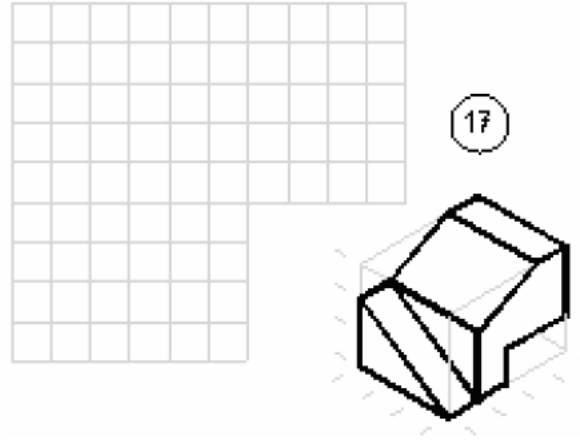

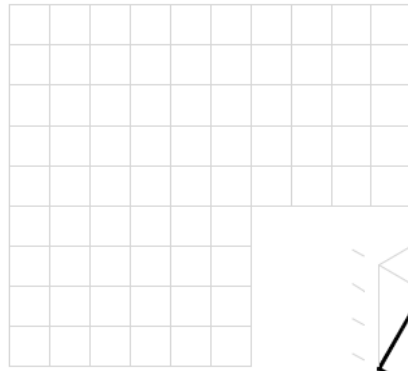

19



20

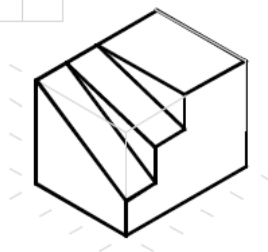

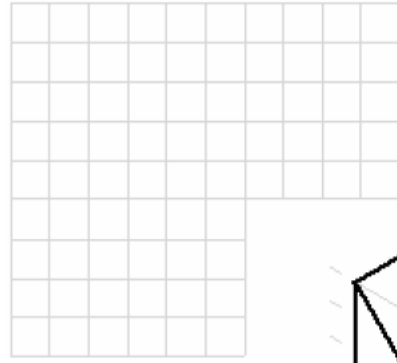

21

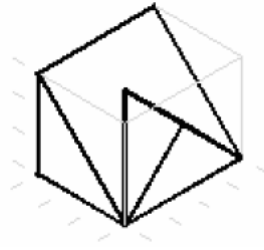

22

